

Movinor[®] T AC Servomotors

Features

- Ultra compact size
- High torque
- Possible additional inertia
- Protection IP-65

Power

- Stall torque 0.10 to 115 Nm
- Sizes 37, 55, 86, 98, 142, 190 & 240 mm

Executions

- Wide range of standard models
- Customized versions
- CE and UL certifications
- ATEX versions

Movinor[®] T, AC servomotors

The brushless synchronous servomotors with 6-pole stator are constructed and designed completely new. The modern concept of the magnetic circuit, winding and isolation creates torque reserves and increases the lifetime considerably.

Technical data

Type	Torque	Speed	Winding C (230VAC)		Winding D (400VAC)		Length ¹		
			I_o	n_{max}	I_o	n_{max}	without brake	with brake	
	M_o	n_{nom}	I_o	n_{max}	n_{max}	I_o	n_{max}	K [mm]	K1 [mm]
	[Nm]	[tr/min]	[Arms]	@230VAC [rpm]	@400VAC [rpm]	[Arms]	@400VAC [rpm]		
T037-1	0.10	6 000	0.59	10 000	10 000	–	–	81	111
T037-2	0.20	6 000	0.95	10 000	10 000	–	–	96	126
T037-3	0.30	6 000	0.95	10 000	10 000	–	–	111	141
T055-1	0.20	4 500	0.59	8 500	10 000	0.48	10 000	98	131
T055-2	0.40	4 500	0.93	7 000	10 000	0.54	10 000	113	146
T055-3	0.60	4 500	1.22	6 000	10 000	0.72	10 000	128	161
T055-4	0.80	4 500	1.56	6 000	10 000	0.91	10 000	143	176
T086-1	0.65	4 500	1.38	6 500	10 000	0.78	6 800	109	142
T086-2	1.30	4 500	2.36	6 000	10 000	1.43	6 500	127	160
T086-3	2.50	4 500	4.03	5 500	10 000	2.60	6 300	163	196
T086-4	3.00	4 500	4.84	5 500	10 000	2.90	5 800	181	214
T098-1	2.60	3 000	3.10	4 000	7 200	1.92	4 300	146	178
T098-2	5.30	3 000	6.46	4 000	7 200	4.10	4 500	176	208
T098-3	7.50	3 000	9.04	4 000	7 200	4.80	3 800	221	253
T142-1	6.60	3 000	7.70	3 700	6 800	4.50	3 800	185	228
T142-2	10.50	3 000	13.30	4 200	7 600	7.30	4 100	219	262
T142-3	13.50	3 000	17.30	4 300	7 700	11.20	4 900	236	279
T142-4	17.00	3 000	18.30	3 600	6 500	11.40	4 000	270	313
T142-5	22.00	3 000	25.60	3 900	7 000	12.80	3 400	304	347
T190-1	13.50	3 000	14.50	3 600	6 500	8.20	3 600	201	254
T190-2	19.00	3 000	22.90	4 100	7 400	13.90	4 400	235	288
T190-3	22.00	3 000	25.60	4 000	7 100	14.60	4 000	252	305
T190-4	29.00	3 000	31.20	3 700	6 700	17.20	3 600	310	356
T191-1	27.00	3 000	28.10	3 600	6 500	15.80	3 700	242	296
T191-2	32.00	3 000	32.70	3 600	6 400	18.90	3 700	257	311
T191-3	40.00	3 000	44.00	3 900	6 900	24.70	3 800	287	341
T240-1	40.00	3 000	–	–	–	21.70	3 300	311	379
T240-2	68.00	2 000	–	–	–	25.20	2 300	379	447
T240-3	93.00	2 000	–	–	–	33.20	2 200	447	515
T240-4	115.00	2 000	–	–	–	42.60	2 200	515	583

¹ Length for motors with resolver and 0° straight or 90° angled connectors towards rear (except size 37 = cables as standard)

Brake

Motor type	T037	T055	T086	T098	T142	T190	T191	LT240
Torque [Nm]	0.4	2.0	4.5	9.0	18.0	36.0	36.0	145.0
Supply [VDC]	24 (+6% – 10%)							

Mechanical dimensions

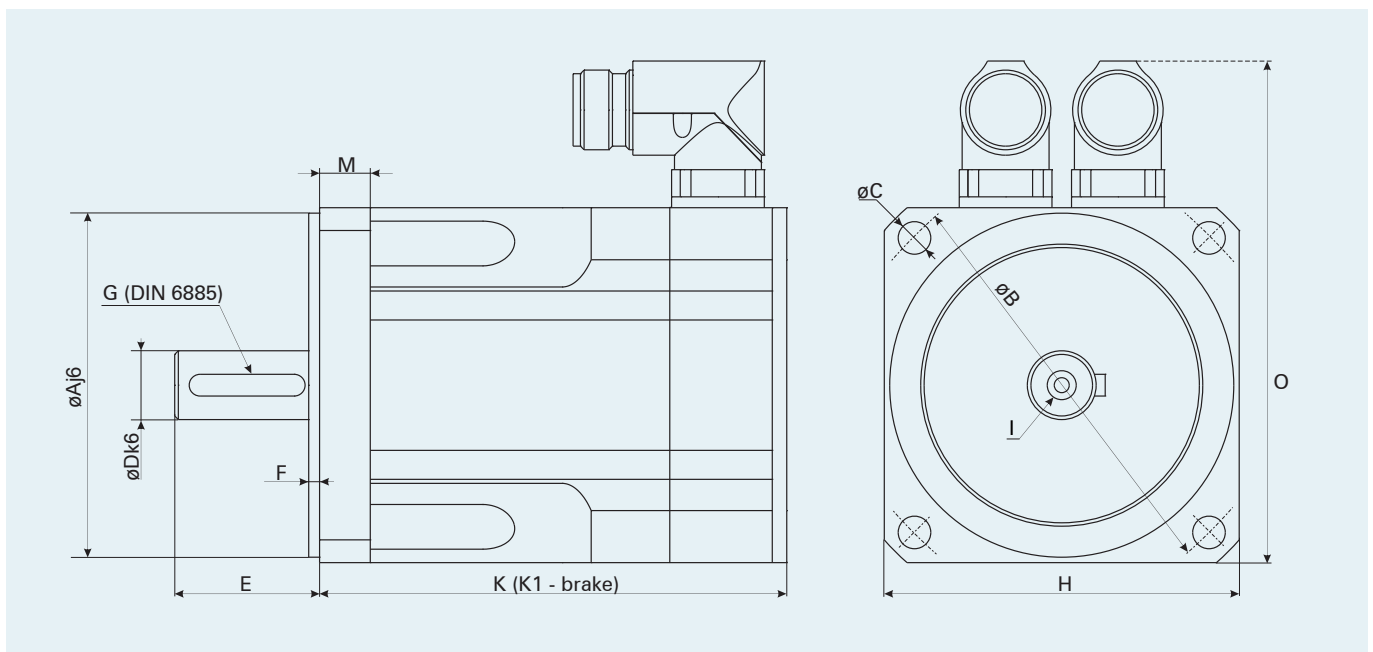

Dimensions [mm]	$\varnothing A_{j6}$	$\varnothing B$	$\varnothing C$	$\varnothing D_{k6}$	E	F	G	H	I	M	O
T037	25	32	M3x7	6	16	2.0	2x2x10	37	-	-	71
T055	40	63	4x5.8	9	24	2.5	3x3x18	55	M3x7 (opt)	7	97
T086	80	100	4x7.0	14	30	3.0	5x5x22	86	M4x10	11	120
T098	95	115	4x9.0	19	40	3.0	6x6x32	98	M5x14	14	137
T142	130	165	4x12.0	24	50	3.5	7x8x40	142	M8x20	14	174
T190	180	215	4x12.0	24	50	3.5	7x8x40	190	M8x19	12	213
T191	180	215	4x14.0	28	58	3.5	7x8x40	190	M10x22	15	229
T240 (1-2)	230	265	4x14.5	38	80	4.0	10x8x63	240	M12x30	18	287
T240 (3-4)	230	265	4x14.5	42	110	4.0	12x8x63	240	M12x30	18	287

Standard version

- Resolver feedback
- Shaft without keyway
- Protection IP-65
- Angled connectors 90° towards rear (size 37 = cables)
- PTC sensor
- Windings 230/400VAC (320/560VDC)

Options

- Incremental encoder, SinCos, Hiperface, EnDat
- Shaft with keyway
- Protection IP-67
- Shaft seal
- Straight, 90° towards front or rotatable connectors
- Direct cable output
- NTC, PT1000 sensors
- ATEX II 3G Ex nA II 155°C and ATEX II 3D Ex tc IIIC 155°C according to EN 60079-0/15/31

Customized versions

- Shafts (i.e. hollow shafts)
- Flanges, housings
- Windings
- Connections
- Execution according to customer's specifications

Infranor product range

Drives

Standard drives



Customized drives



Drive applications



Motors

Standard motors



Customized motors



Motor applications



Services

Standard services



User-specific services

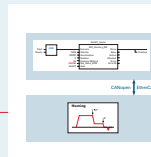

Global solutions

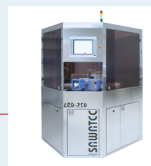

Infranor Group

Infranor creates added value for its customers by providing tailor-made motion solutions.

Based on strong working relationships, Infranor offers extensive market know-how, comprehensive engineering skills and a wide range of high-quality products leading to productivity gains and therefore to comparative advantages for its customers in their respective markets.

Contact

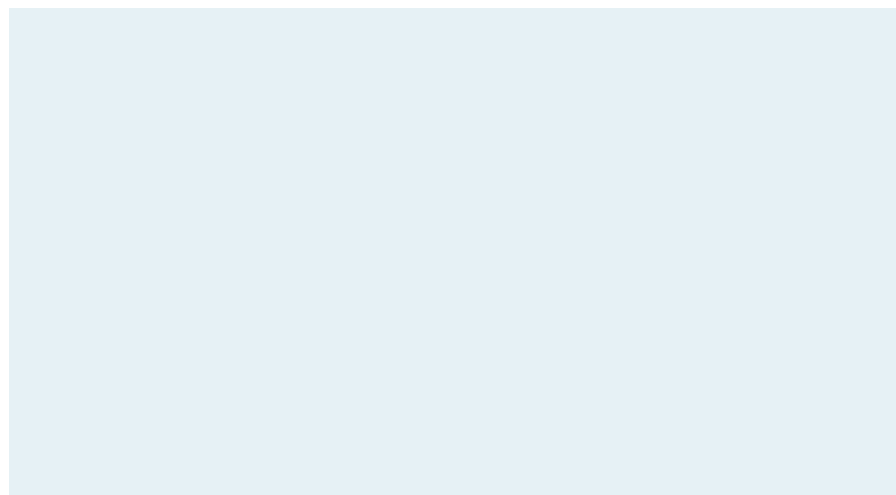

Infranor worldwide

Switzerland
Germany
France
Italy
Benelux
UK
Spain
USA
China

Other representations:
Denmark, Poland, Slovenia,
Israel, India.



www.infranor.com