

Xtrafors Washdown AC Servomotors



Features

- Smooth edges
- Stainless steel housing and shaft
- Protection IP 67

Power

- Torque from 1.28 to 4.75 Nm

Executions

- Wide range of standard models
- Customized versions
- Sizes 134 to 235 mm

XtraforsWashdown, AC Servomotors

The housings of these synchronous servomotors are manufactured from stainless steel with a plain cylindrical shape. The smooth outline makes them particularly well suited for applications in food, medical, pharmaceutical and chemical industries as well as in other similar industrial branches.

Technical data

	Rated torque	Rated speed	Peak speed Winding A		Peak speed Winding 4		
			Rated current	@230VAC	@400VAC	Rated current	@400VAC
	[Nm]	[rpm]	[Arms]	[rpm]	[rpm]	[Arms]	[rpm]
BF-82	1.28	6700	2.67	7450	-	1.60	7900
BF-83	1.70	4650	2.46	5170	8520	0.15	5100
BF-122	3.90	4000	4.70	4350	7550	2.57	4100
BF-124	4.75	4210	5.72	4350	7500	3.28	4300

Torque curves

Winding A @230VAC

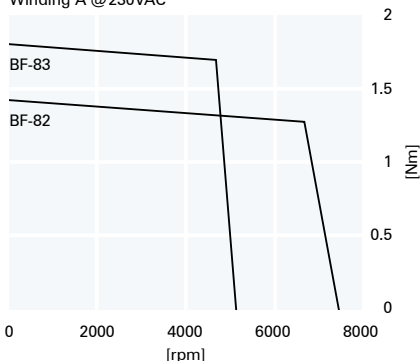

Winding A @230VAC

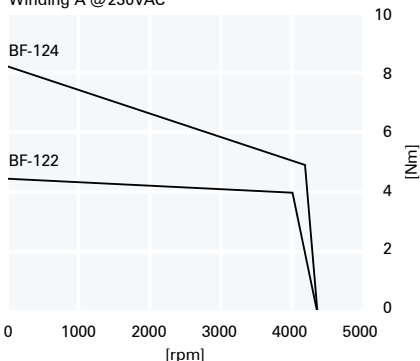

Winding A @400VAC

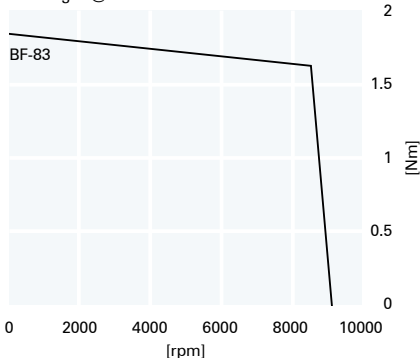

Winding A @400VAC

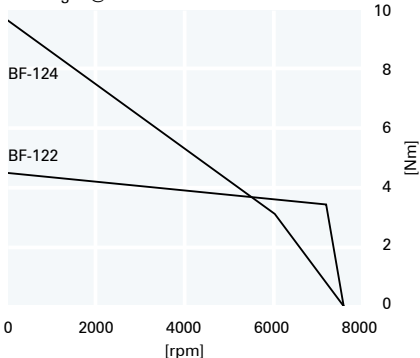

Winding 4 @400VAC

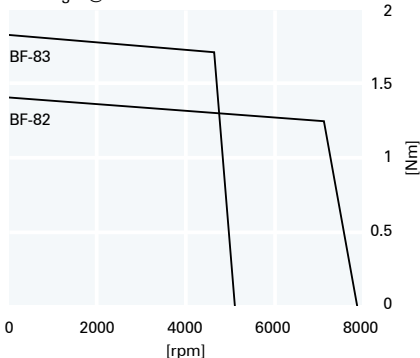

Winding 4 @400VAC

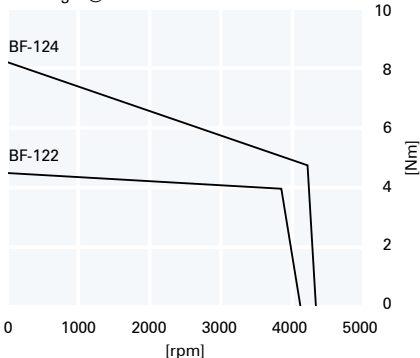

Standard version

- Resolver feedback
- Stainless steel housing
- Stainless steel shaft
- Protection IP 67
- Direct cable output
- NTC thermal sensor
- 230VAC or 400VAC winding

Options

- Various types of incremental encoders
SinCos encoders, Hyperface, EndDat
- Shaft without keyway
- PTC thermal sensor

Customized versions

- Winding

Mechanical dimensions

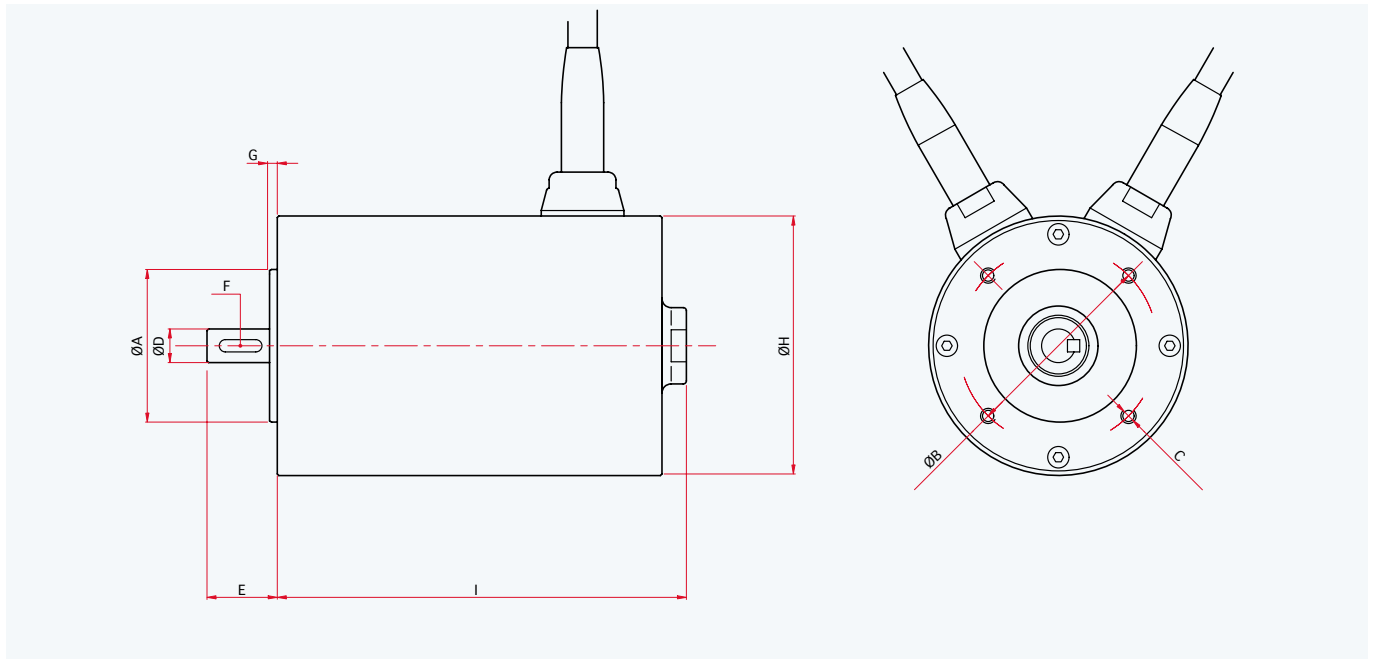

Dimensions [mm]		BF-82	BF-83	BF-122	BF-124
A Ø	j5	50	50	80	80
B Ø		65	65	100	100
C		4xM5	4xM5	4xM6	4xM6
D Ø	k6	11	11	19	19
E		23	23	40	40
F		A4x4x14	A4x4x14	A6x6x30	A6x6x30
G		2.5	2.5	3.0	3.0
H Ø		85	85	125	125
I	without brake	134	152	185	235
	with brake	158	175	206	256

Brakes

Torque	[Nm]	1.5	3.0	8.0	12.0
Tension	[VDC]				24 (+6% - 10%)

Addresses

Switzerland

Infranor SA
Place de la Gare 5
CH-1296 Coppet
Phone +41 22 960 70 70
Fax +41 22 960 70 80
www.infranor.ch
infranor@infranor.ch

Infranor AG
Schaffhauserstrasse 418
CH-8050 Zürich
Phone +41 44 308 50 00
Fax +41 44 308 50 09
www.infranor.ch
infranor@infranor.ch

Germany

Infranor GmbH
Donaustrasse 19a
D-63452 Hanau
Phone +49 6181 18012 0
Fax +49 6181 18012 90
www.infranor.de
info@infranor.de

France

Infranor SAS
3, avenue Louis Delage
F-91310 Linas
Phone +33 1 69 633 515
Fax +33 1 69 633 516
www.infranor-france.com
infranor@infranorfrance.com

Spain

Infranor Spain SL
Occitània, 24
E-08911 Badalona
(Barcelona)
Phone +34 93 460 16 31
Fax +34 93 399 96 08
www.infranor.es
infranor@infranor.es

Benelux

Infranor B.V.
Albert Einsteinstraat 6
NL-3261 LP Oud-Beijerland
Phone +31 186 610 155
Fax +31 186 614 535
www.infranor.nl
info@infranor.nl

England

Infranor Ltd.
Unit 60A, Smithbrook Kilns
Cranleigh
UK-Surrey GU6 8JJ
Phone +44 1483 274 887
Fax +44 1483 276 037
www.infranor.ltd.uk
sales@infranor.ltd.uk

USA

Infranor, Inc.
299 Ballardvale Street Suite 4
USA-Wilmington, MA 01887
Phone +1 978 988 9002
Fax +1 978 988 9112
www.infranorusa.com
info@infranorusa.com

China

**Infranor Motion Control
Technology (Shanghai) Co., Ltd.**
Room 4E, Building A4
No. 700 Yishan Rd
CN-200233 Shanghai
Phone +86 21 6440 1095
Fax +86 21 6440 1095
www.infranor.cn
info@infranor.cn

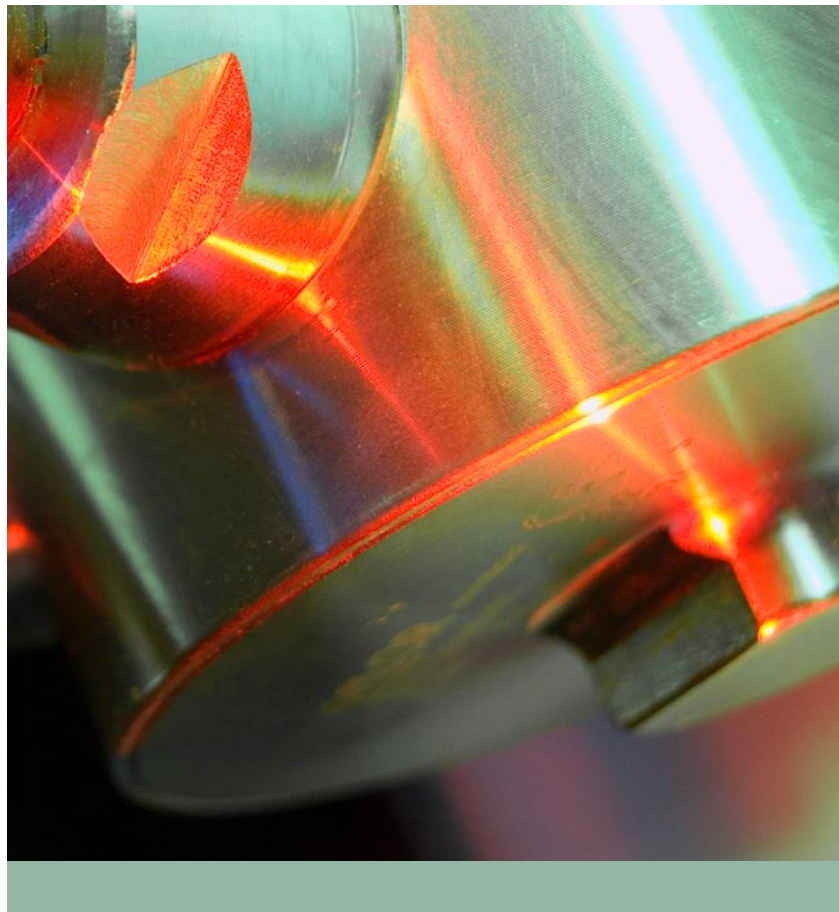

The Infranor Group

Infranor creates added value for its customers by providing tailor-made motion solutions.

Based on strong working relationships, Infranor offers extensive market know-how, comprehensive engineering skills and a wide range of high-quality products leading to productivity gains and therefore to comparative advantages for its customers in their respective markets.

The Infranor Brand

The Infranor Brand is a synonym for:

- Excellence
- Cooperation
- Added value